

SOSEN LED Driver, Your Smart Choice

Specifications

SS-200VA Series LED Driver

Model: SS-200VA-56*

Description: 200W LED Driver

Rev.: V04

Release Date: 2020-03-23

SS-200VA Series LED Driver

SOSEN
LED DRIVER



LED DRIVER

VA Series



Features:

- ❑ Efficiency up to 93%
- ❑ Isolated dimming: 1-10V, PWM, Resistor, Timing
- ❑ IP67
- ❑ Protections: SCP/OTP/OVP/OPP
- ❑ Comply with the Class P
- ❑ TYPE HL, suitable for hazardous locations
- ❑ Surge protection: L/N-PE: 10kV, L-N: 6kV
- ❑ Warranty: 5 years



IP67 Class P

Description :

SS-200VA is a rectangular driver with 90-305Vac input, the 200W model are designed for street and area lights with IP67 and 10kV/6kV surge protection. It has UL listed mark with Class P and Type HL rated.

Model List:

Model	AC Input Range	Max. Pout	Vout Range	Full Power Vo Range	Iout	THD(Typ.)	PF(Typ.)	Eff.(Typ.)	Max.Tc
SS-200VA-56*	90-305Vac	200W	22-56V	36-56V	2.8-5.6A	8%	0.98	93%	90°C

1.Default tested at 220Vac, full load, Ta 25°C.

2.“*”Optional B or space in the place of * means additional function.

- Space is the base model without any optional function;
- Suffix B for model with 3-in-1 dimming (1-10V, PWM, Resistor);
- Suffix T for model with Timing.

SS-200VA Series LED Driver

Input Characteristics:

Parameter	Min.	Typ.	Max.	Remark
Rated AC Input Range	100Vac		277Vac	
AC Input Range	90Vac		305Vac	
Input Frequency Range	47Hz	50/60Hz	63Hz	
Max Input Current			2.4A	100Vac, Full load
Max Input Power			227W	100Vac, Full load
Max Inrush Current(120Vac)			60A	Cold start
Max Inrush Current(220Vac)			110A	Cold start
Max Inrush Current(277Vac)			125A	Cold start
No Load Power			3W	220Vac/50Hz, No load
Power Factor	0.96	0.98		220Vac/50Hz, Full load
	0.90			100-277Vac/50Hz, 70-100% load
THD		8%	10%	220Vac/50Hz, Full load
			20%	100-277Vac/50Hz, 70-100% load

SS-200VA Series LED Driver

Output Characteristics:

Parameter	Min.	Typ.	Max.	Remark
Output Voltage Range	22V		56V	Power derated @22-36V
Rated Output Voltage	36V		56V	$P_o = V_o \cdot I_o = 200W$, Full load
Rated Output Current	3.6A		5.6A	5.6A for 36V, 3.6A for 56V
Current Adjustable Range(AOC)	2.8A		5.6A	
No Load Voltage			60V	
Efficiency @120Vac	90.0%	91.0%		Output 44V/4.6A
Efficiency @220Vac	92.0%	93.0%		Output 44V/4.6A
Efficiency @277Vac	92.5%	93.5%		Output 44V/4.6A
Output Current Tolerance	-5%		+5%	
Output Current Ripple(PK-AV)		5%	10%	Full load
Start-up Current Overshoot			10%	Full load
Start-up Time			0.5S	120Vac
			0.5S	220Vac
Line Regulation	-2%		+2%	Full load
Load Regulation	-2%		+2%	
Temperature Coefficient	-0.03%/°C		+0.03%/°C	Tc: 0°C~90°C
OTP	90°C	100°C	110°C	Tc, Decreases output current, returning to normal after over temperature is removed.
Short Circuit Protection			10W	Driver will not be damaged, Hiccup mode

SS-200VA Series LED Driver

Other Characteristics:

Parameter		Min.	Typ.	Max.	Remark
1-10V Dimming (Optional)	Dim Vmax	0V		12V	
	Dim Range	10%Iomax		100%Ioset	
	Rec.Dim Range	1V		10V	
PWM Dimming (Optional)	PWM High	9.8V		10.2V	
	PWM Low	0V		0.3V	
	Frequency	1KHz		2KHz	
	PWM Duty	10%		100%	
Resistor Dimming (Optional)	Resistance	10Kohm		100Kohm	
	Dim Range	10%Iomax		100%Ioset	
Timing Curve(Optional)		By programming			Set by program (Externally programmable)
Lifetime(Tc≤72°C)		≥62,000 hours			80% load
MTBF		164,000 hours			220Vac, Full load, Ta=25°C (MIL-HDBK-217F)
IP Grade		IP67			
Tc		90°C			
Warranty		5 years			Refer to life time drawing
Net Weight		1100g			
Dimension		222mm*71mm*39.6mm			L x W x H

NOTE: All the parameters above are tested Ta 25°C, unless specified.

SS-200VA Series LED Driver

Environmental Requirements

Parameter	Min.	Typ.	Max.	Remark
Operating Temperature(Tcase)	-40°C	25°C	+90°C	
Storage Temperature	-40°C	25°C	+85°C	
Operation Humidity	10%RH		90%RH	
Storage Humidity	5%RH		95%RH	
Altitude	-65m		4000m	

Safety and EMI/EMS Standards

Certification	Standard	Status	Remark
UL/cUL	UL8750	✓	
ENEC	IEC 61347-2-13:2014/AMD1:2016 used in conjunction with IEC 61347-1:2015	✓	
RCM	AS/NZS61347.2.13	✓	
CCC	GB 19510.14-2009	✓	
CE	EN 61347-2-13:2014 EN61347-1:2008+A1:2011+A2:2013	✓	

EMI/EMS	Criterion	Remark
Conduction Emission	EN55015:2013+A1:2015	
Radiation Emission	EN55015:2013+A1:2015	
Harmonic Current Emissions	IEC/EN 61000-3-2	Class C
Surge	IEC/EN61000-4-5	Difference mode 6kV, Common mode 10kV,Criterion B
Ring Wave	IEC/EN 61000-4-12	Difference mode 6kV, Common mode 6kV,Criterion B

SS-200VA Series LED Driver

Safety Test Items:

Safety test items	Technical Indicators			Remark
Insulation Requirements	UL Insulation Requirements	TUV Insulation Requirements	CCC Insulation Requirements	
Input-Output	1600Vac	3000Vac	3750Vac	Reinforced insulation
Input-Case	1600Vac	1500Vac	1875Vac	Basic insulation
Input-Dim	1600Vac	3000Vac	3750Vac	Reinforced insulation
Output-Dim	1600Vac	1000Vac	1000Vac	Additional insulation
Output-Case	500Vac	1000Vac	1000Vac	Function insulation
Dim-Case	500Vac	250Vac	500Vac	
Insulation Resistance	≥10MΩ			Input-Output, Test voltage:500Vdc
Ground Resistance	≤0.1Ω			25A/1min
Leak Current	≤0.75mA			277Vac

NOTE:

1. SOSEN warrants the LED Driver itself meets with EMC standard. However, LED Driver's EMC should be re-checked when integrated into lighting systems due to unexpected interference as component.
2. Please short Line and Neutral, LED+ and LED-, Dim+ and Dim - when Hi-pot test.
3. The CCC withstand voltage test needs to disconnect the built-in lightning protection tube. According to the IEC 60598-1:14 standard section 10.2, the "built-in lightning protection tube" can be marked on the nameplate to disconnect the discharge tube on testing.

Performance Curves:

Input Inrush Current

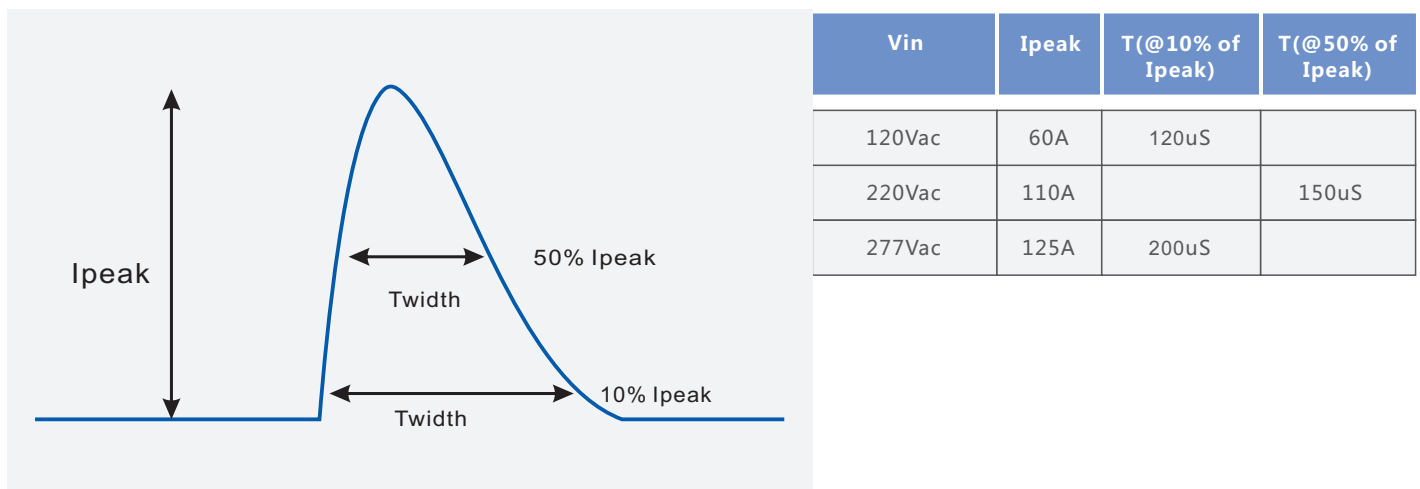

SS-200VA Series LED Driver

Performance Curves:

Output Voltage Vs. Output Current(Dim/AOC Window)

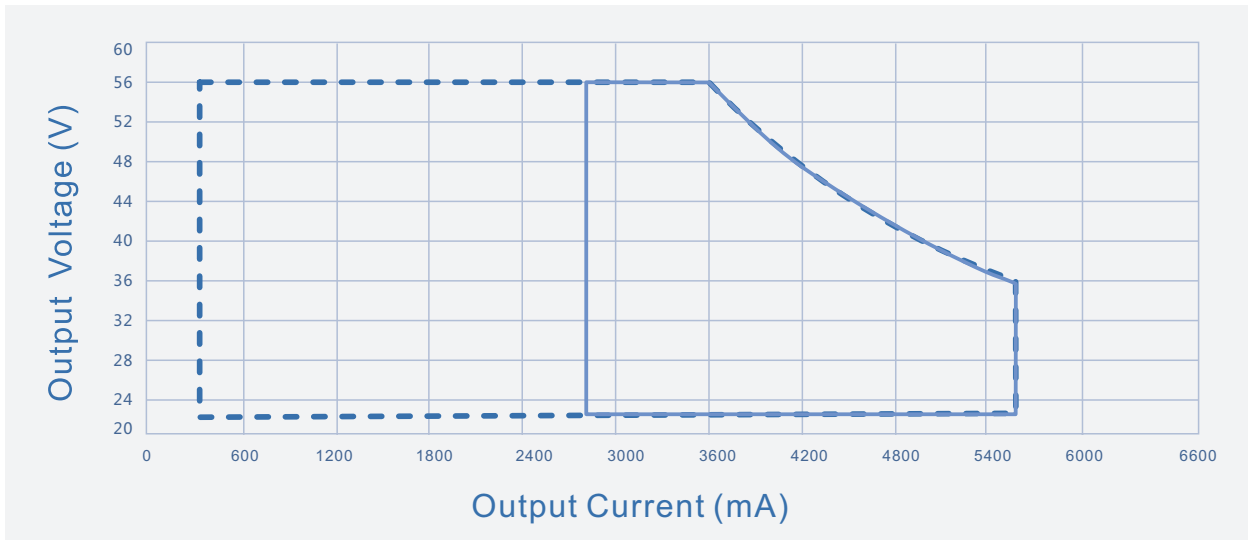

----- Dimming Window ————— AOC Window

Efficiency Vs. Output Voltage (Vin=120Vac)

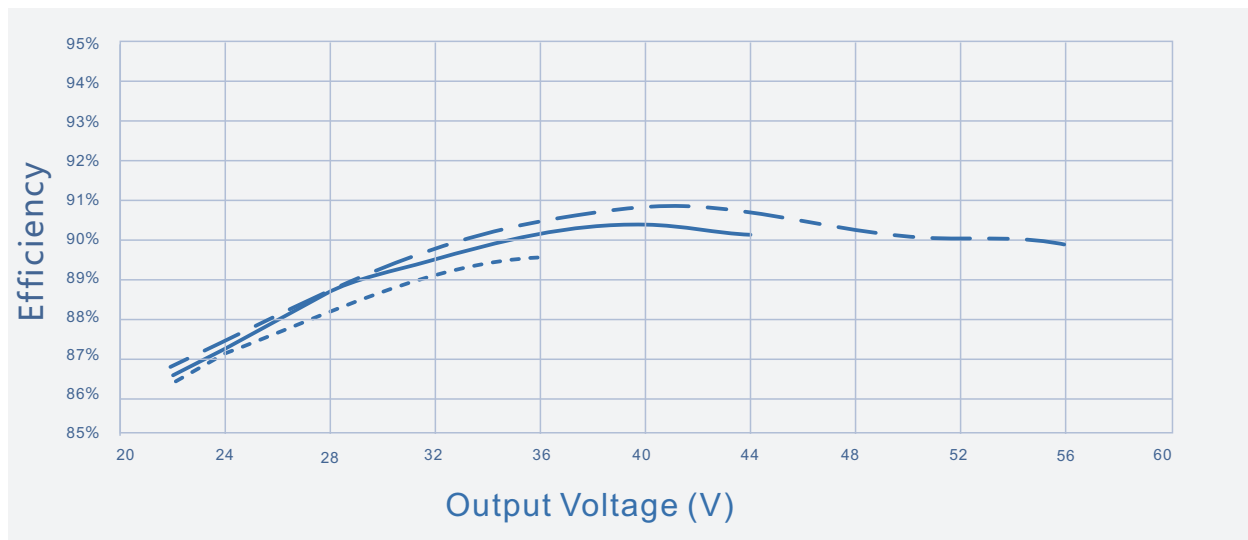

----- Io=5600mA ————— Io=4600mA - - - - Io=3600mA

SS-200VA Series LED Driver

Performance Curves:

Efficiency Vs. Output Voltage ($V_{in}=220V_{ac}$)

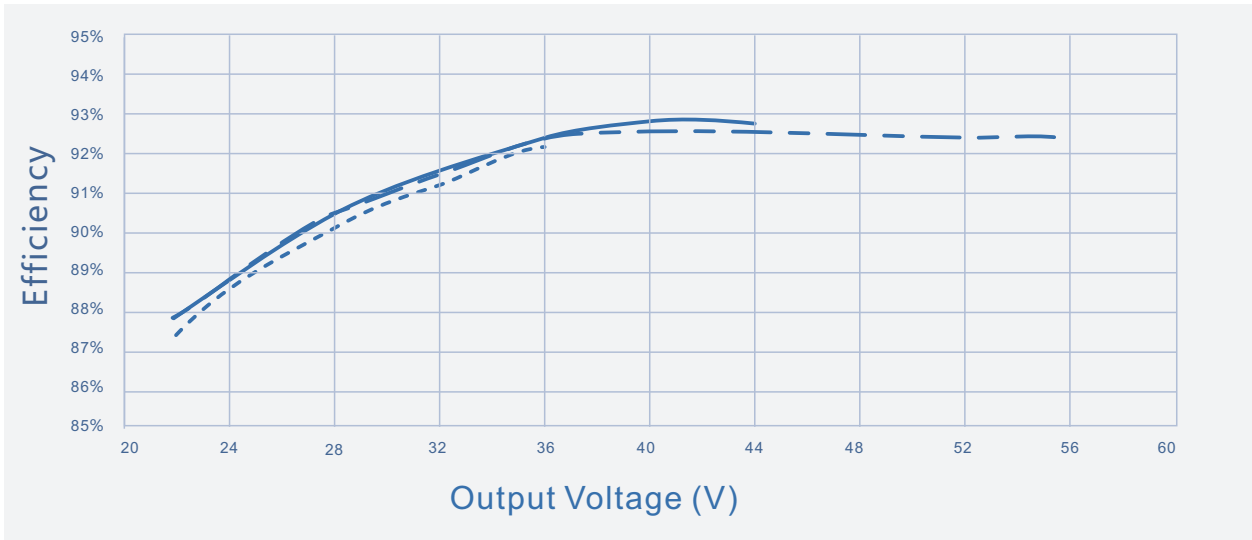

----- $I_o=5600mA$ ———— $I_o=4600mA$ - - - - $I_o=3600mA$

Efficiency Vs. Output Voltage ($V_{in}=277V_{ac}$)

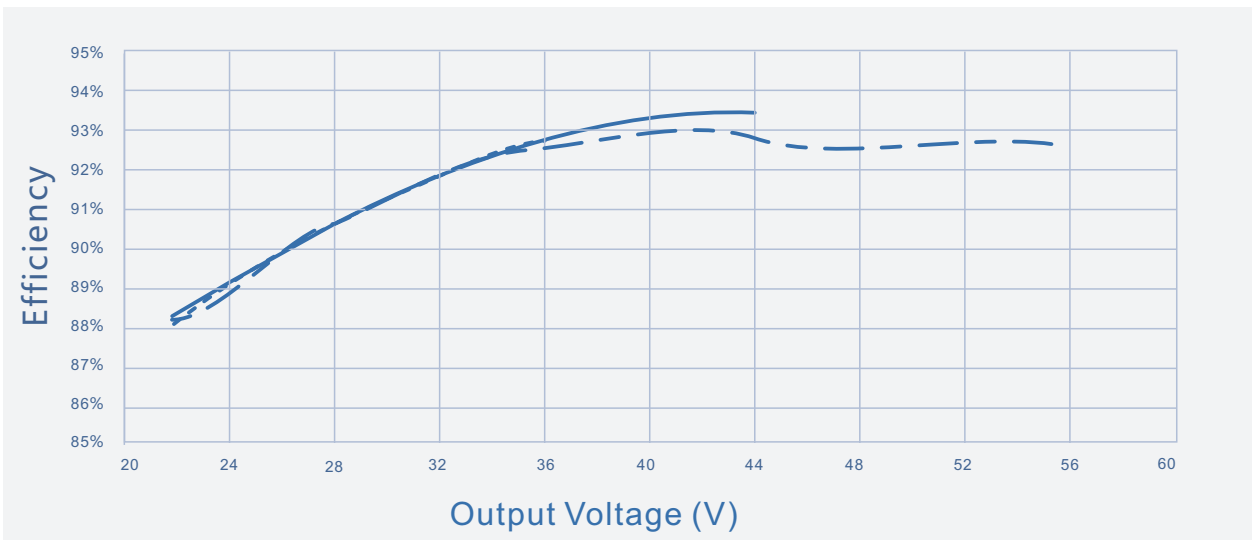

----- $I_o=5600mA$ ———— $I_o=4600mA$ - - - - $I_o=3600mA$

SS-200VA Series LED Driver

Performance Curves:

Power Factor Vs. Output Power

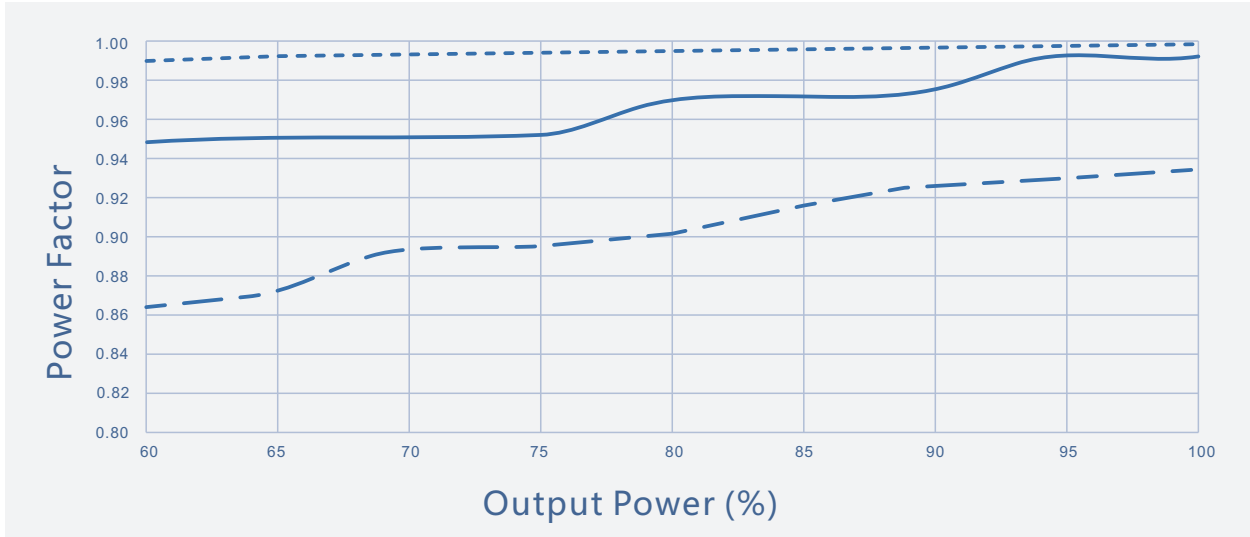

----- Vin=120Vac ——— Vin=220Vac - - - Vin=277Vac

THD Vs. Output Power

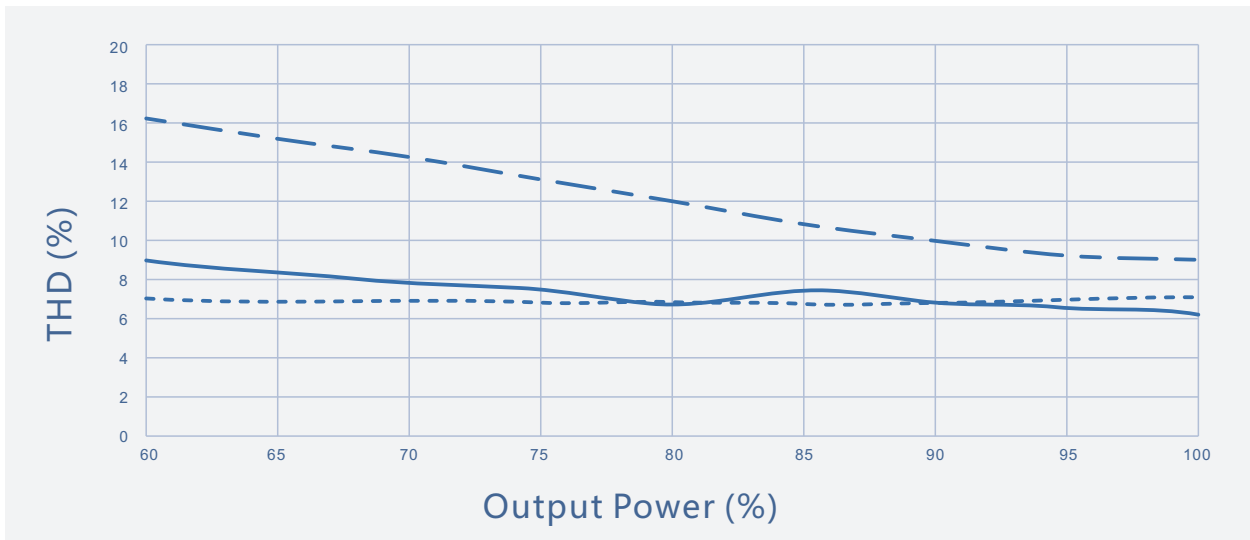

----- Vin=120Vac ——— Vin=220Vac - - - Vin=277Vac

SS-200VA Series LED Driver

Performance Curves:

Output power Vs. Input Voltage
(Ta Max.60°C)

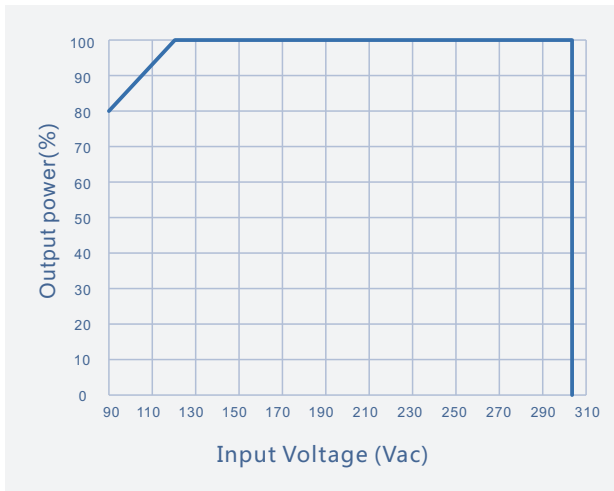

Output power Vs. Case Temperature

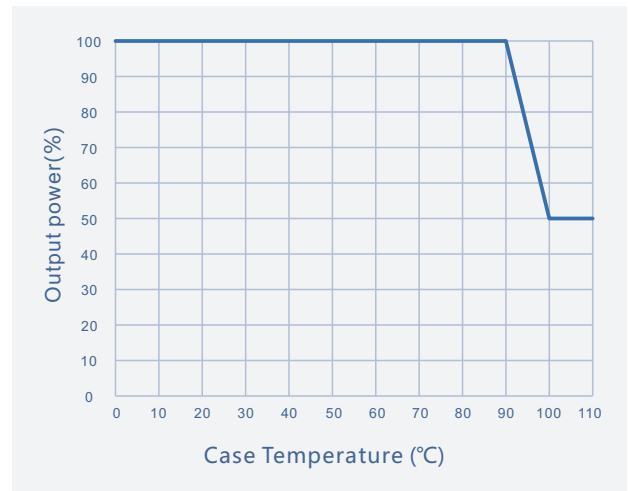

Output Power Vs. Dimming

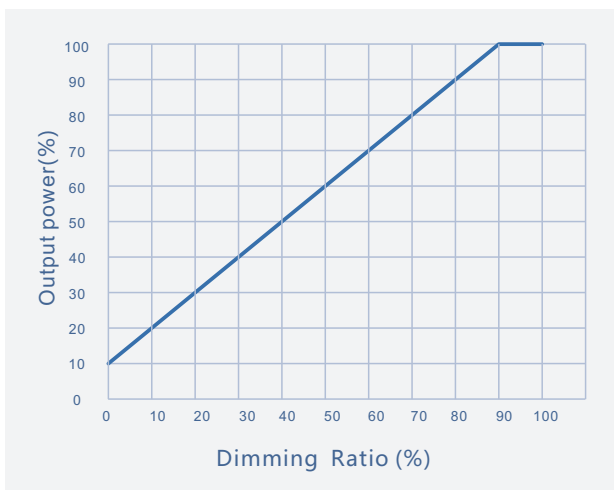

Lifetime Vs. Case Temperature

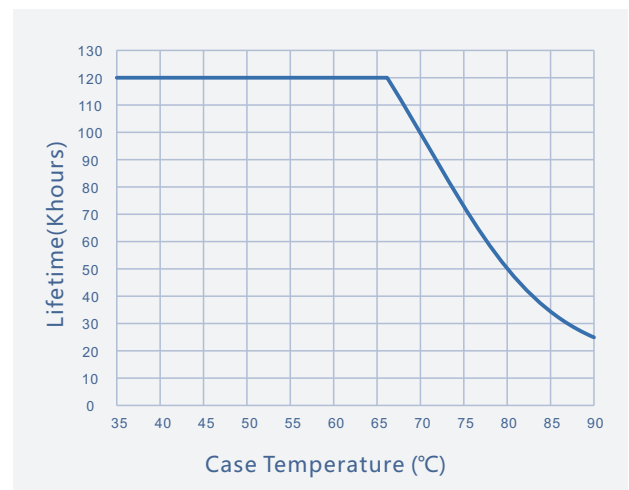

SS-200VA Series LED Driver

Constant Lumen Output

Constant Lumen Output are design to maintain fixture's stable output lumen by increasing driver's output current within driver's life span to counteract LED lumen degradation.

Timing model programming connection diagram (only for suffix "T model") :

Legacy Timer: Driver's output follows the pre-programmed timing curve after turn-on.

Auto-Adjust by Percentage: Driver's output will be adjusted by automatically changed dimming curve by the period percentage based on the latest 5 dimming curve.

Auto-Adjust by Mid-point: Driver's output will be adjusted by automatically changed dimming curve by mid-point based on the latest 5 dimming curve.

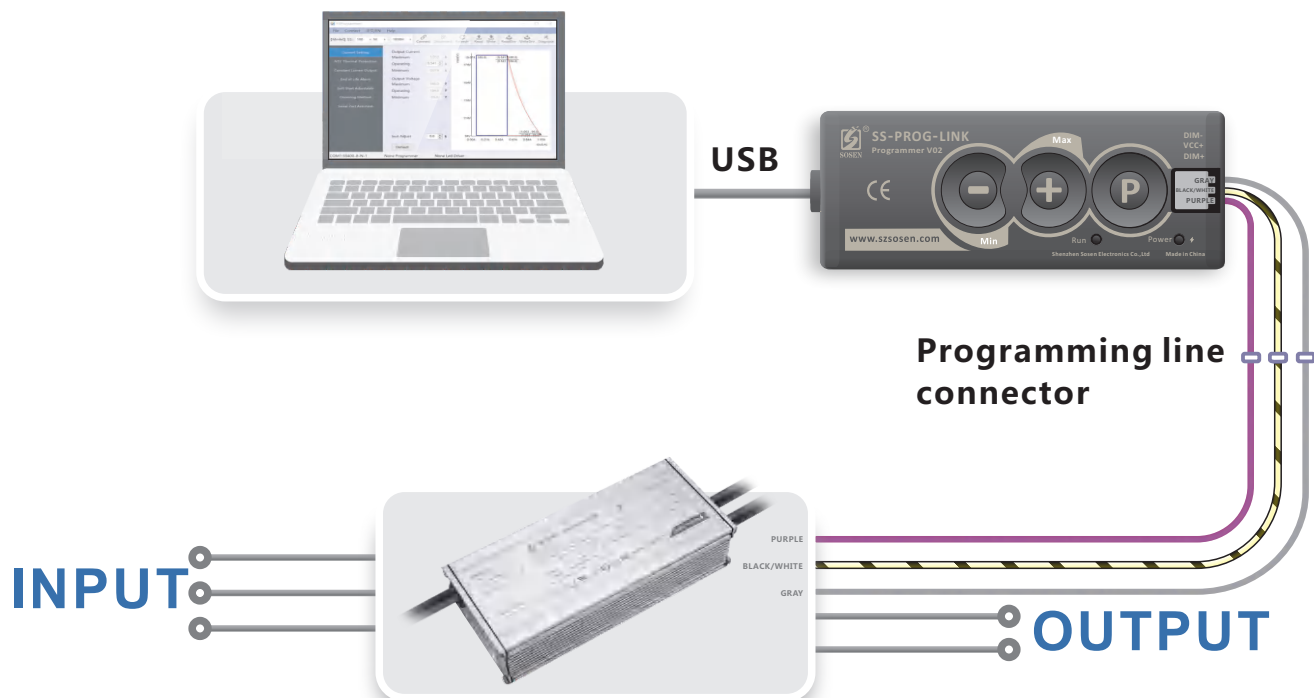

Note:

For details, please refer to the Sosen SS-PORG-LINK Programmer Manual.

SS-200VA Series LED Driver

Mechanical characteristics(Unit: mm)

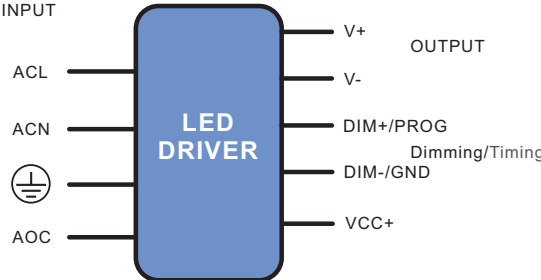

LED DRIVER

AC Input Cable(Lead Length outside enclosure 450±10mm):
 UL model: SJTW,3*0.824mm²,O.D: 7.8mm,Black:L, White:N,Green:⊕
 Global model: SJOW,3*17AWG(1.04mm²),O.D:8.5mm,Brown:L, Blue:N, Yellow/Green:⊕

DC Output Cable(Lead Length outside enclosure 250±10mm):
 UL model: SJTW,2*1.3mm²,O.D: 8.0mm,Red:V+ , Black:V-
 Global model: SJOW,2*17AWG(1.04mm²), O.D:7.9mm, Brown:V+ , Blue:V-

DIM/Timing Cable(Lead Length outside enclosure 220±10mm):
 UL/Global model(B model): STYLE 21996#22AWG , O.D: 4.7mm , Purple : DIM+ , Gray: DIM-
 UL/Global model(T model): STYLE 21996#22AWG , O.D: 4.9mm , Purple : PROG, Gray: GND , Black/White: VCC+

Name Description	Standard Code	mm(In.)
Case Length	L3	197(7.76)
Case Width	W1	71(2.8)
Case Height	H	39.6(1.56)
Overall Length	L1	222(8.74)
Mounting Hole Length	L2	207(8.15)
Mounting Hole Width	W2	34(1.34)
TC point position	X	95(3.74)
TC point position	Y	46(1.81)

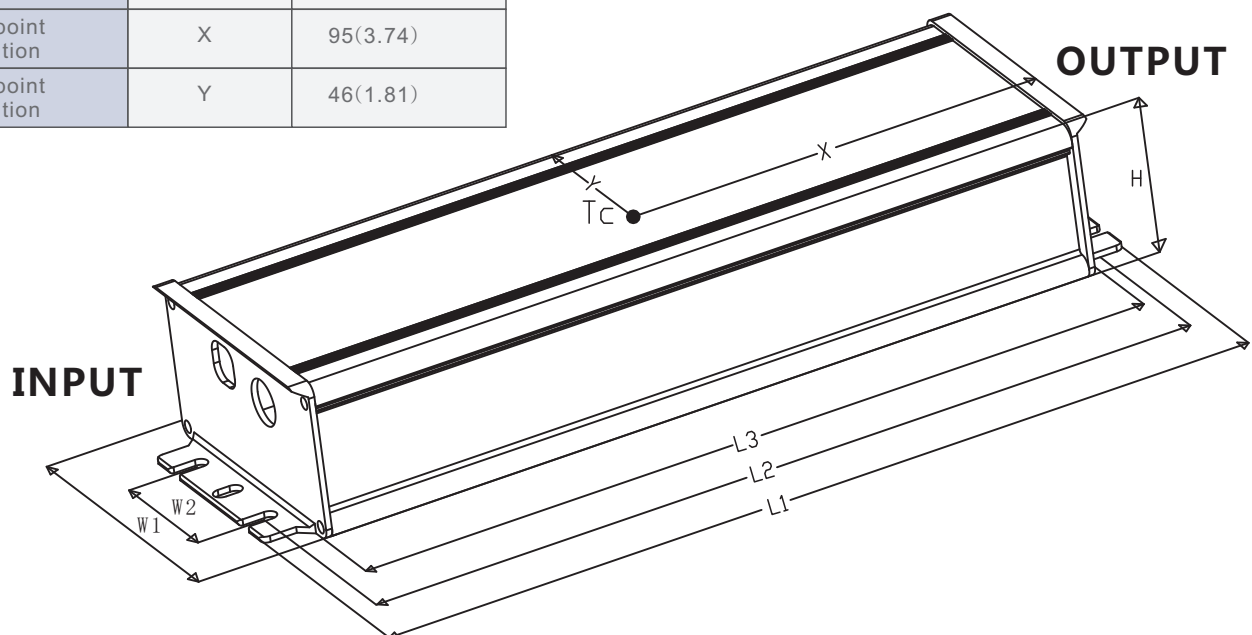

SS-200VA Series LED Driver



Installation Tips

1. Highly recommended to seal the adjustable hole with silicon glue(#704 preferred) after adjusting the driver's output current. Torsion with proper strength to avoid permanent damage to the potentiometer inside.
2. Dimming leads should be capped if not in use to avoid dimming circuit damage caused by external signals.

Package

- Outside carton dimension: L×W×H =500mm×390mm×170mm;
- 14PCS/Carton;
- Net weight/PC: 1.1kg;Gross weight/Carton: 16.4kg;
- Please refer to the product name, model number, manufacturer identification, quality inspection certificate, manufacturing date Etc. on the package. and LED power supply instruction manual in the package.

Transportation

Packaging is designed suitable for transportation by trucks, vessels and flights. The products should be shielded from direct sunshine, loaded/unloaded with caution.

Storage

The product storage meets the standard of the GB 3873 - 83.
Products should be rechecked if stock for over 1 year before installation.

RoHS

Products comply with European directive 2011/65/EC.

REVISION HISTORY

Version	Description of Change	Changed Date	Remark
V00	Original release	2018/10/18	
V01	Update structure diagram	2019/04/04	
V02	Update wire description	2019/07/04	
V03	Increase timing function	2020/01/08	
V04	Update programming diagram	2020/03/23	

